

A FRESH TAKE ON THE LATEST TRENDS
IN MILLWORK AND DESIGN.



SOUNDPLY

FREESTILE



developed & manufactured by

NAVY ISLAND



FREESTILE

A SIMPLE SYSTEM OF READY-MADE
PANELS, STILES, AND TRIM

- ADDS QUIET TO YOUR SPACE
- WON'T SHRINK, SWELL, OR WARP
- FAST TURN-AROUND & EASY INSTALL
- FINISHES FROM LIGHT TO DARK
- ENABLES DESIGN VERSATILITY

FREESTILE

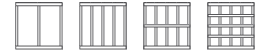

ADD QUIET TO YOUR SPACE

The SoundPly $\frac{3}{4}$ " panels offer a noticeably quieter room as a result of our patented acoustic technologies.

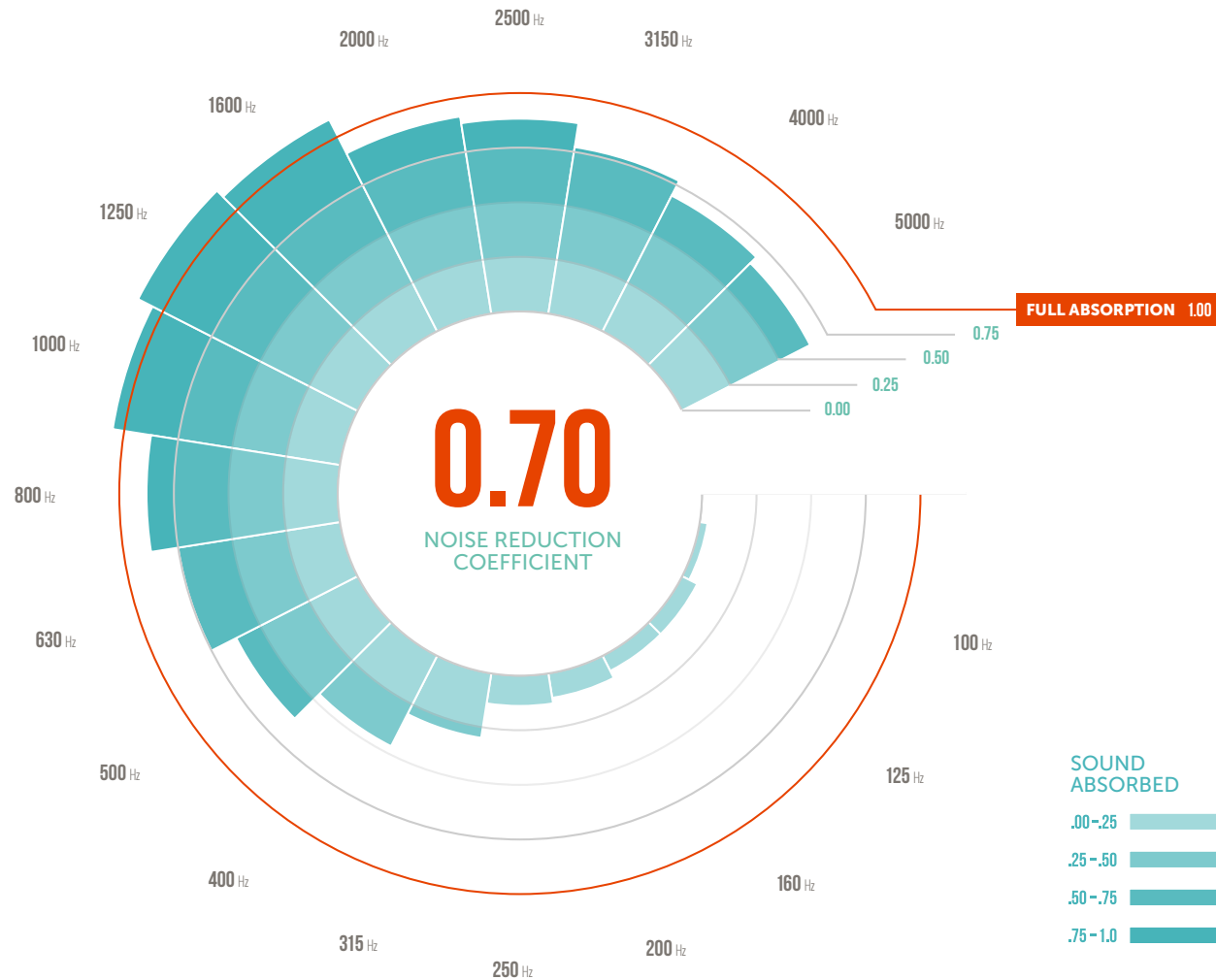

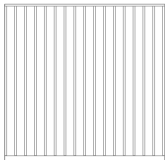

MAPLE



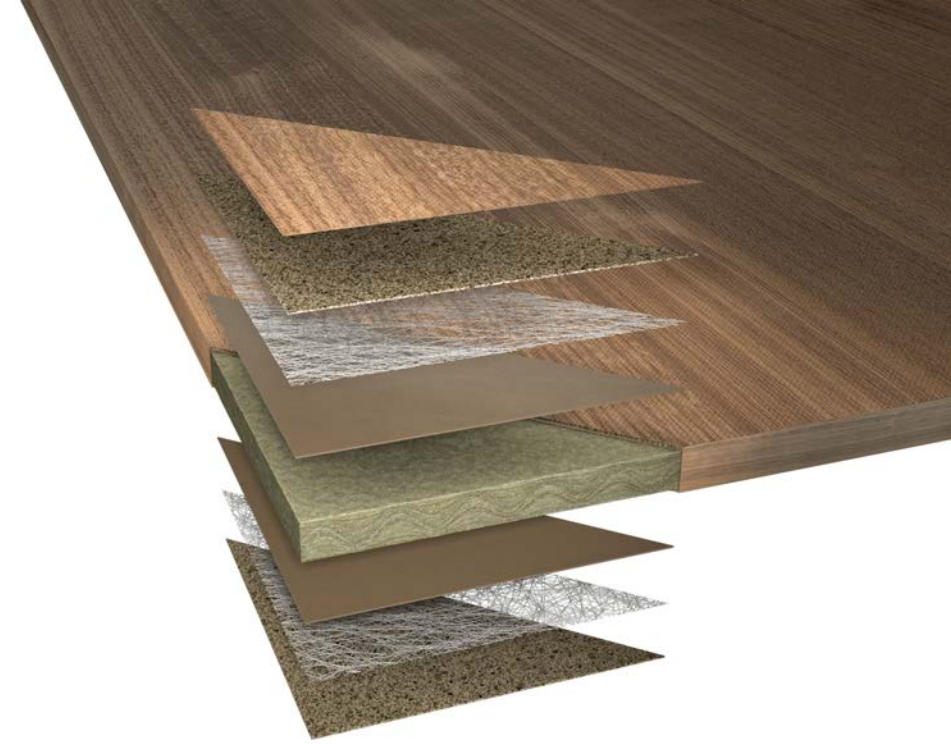
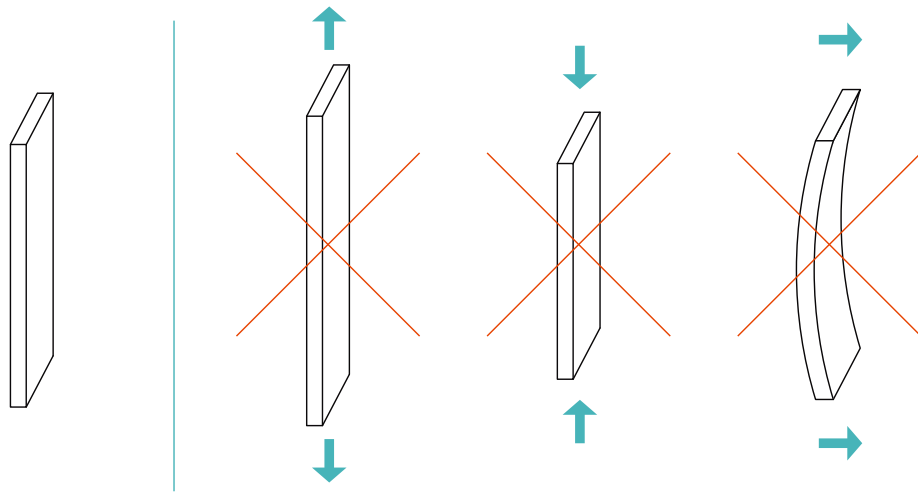

PANELS WON'T EXPAND, CONTRACT OR WARP

SoundPly panels owe their exceptional structural properties to their cutting-edge, patented core construction. The result is a lightweight, stable panel that is secured directly to the wall.

UNLIKE TRADITIONAL HARD PANELS, SoundPly Panels remove the risk of expansion, contraction, and warping.

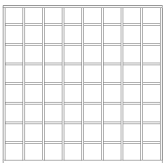

WHITE OAK

FREESTILE

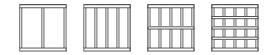

A READY SYSTEM

Freestile is easily installed with standard tools. Measure, cut and assemble on site for a custom layout specific to your space.

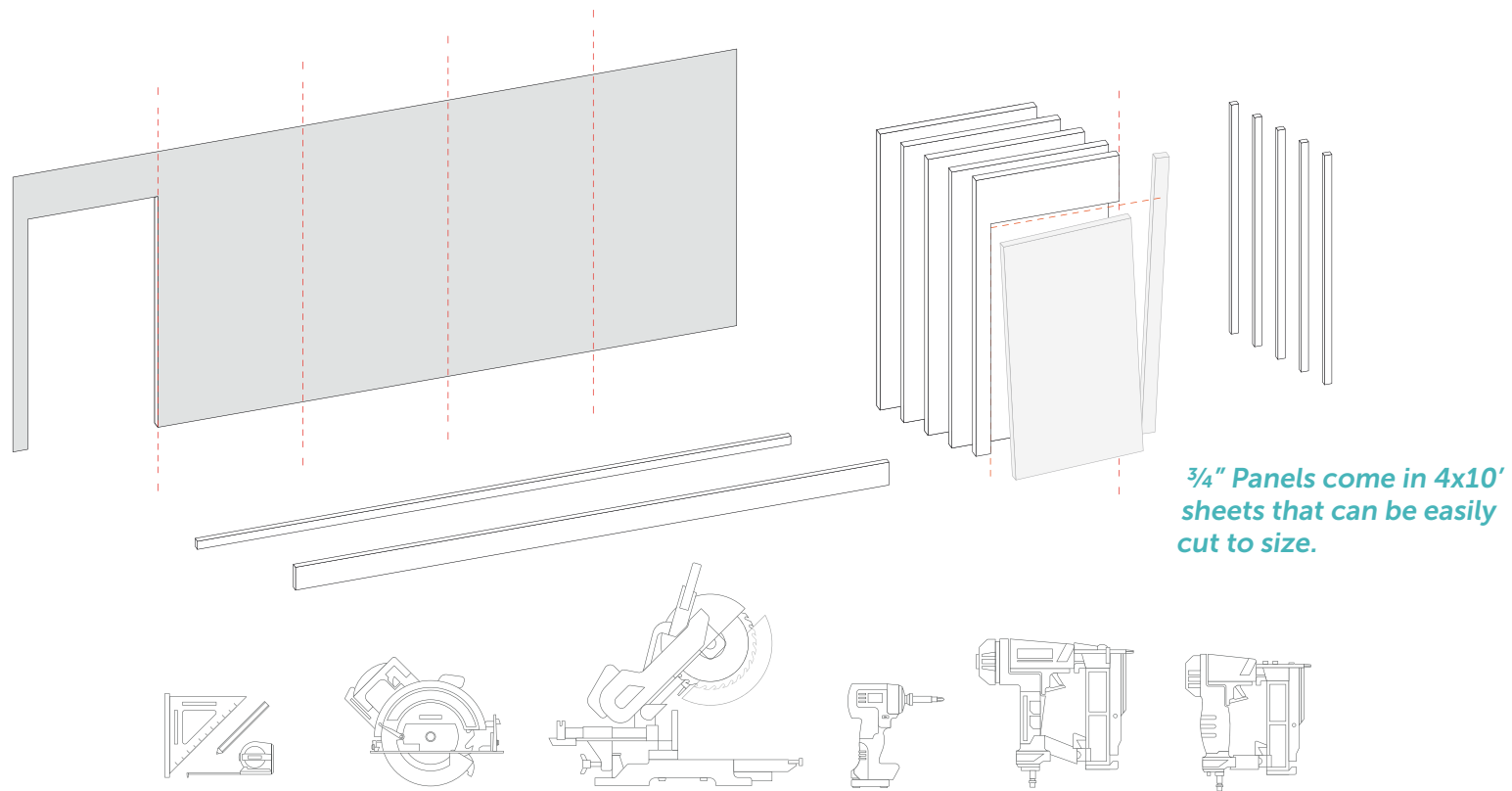

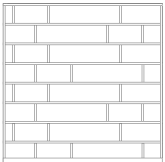

TEAK



MAPLE

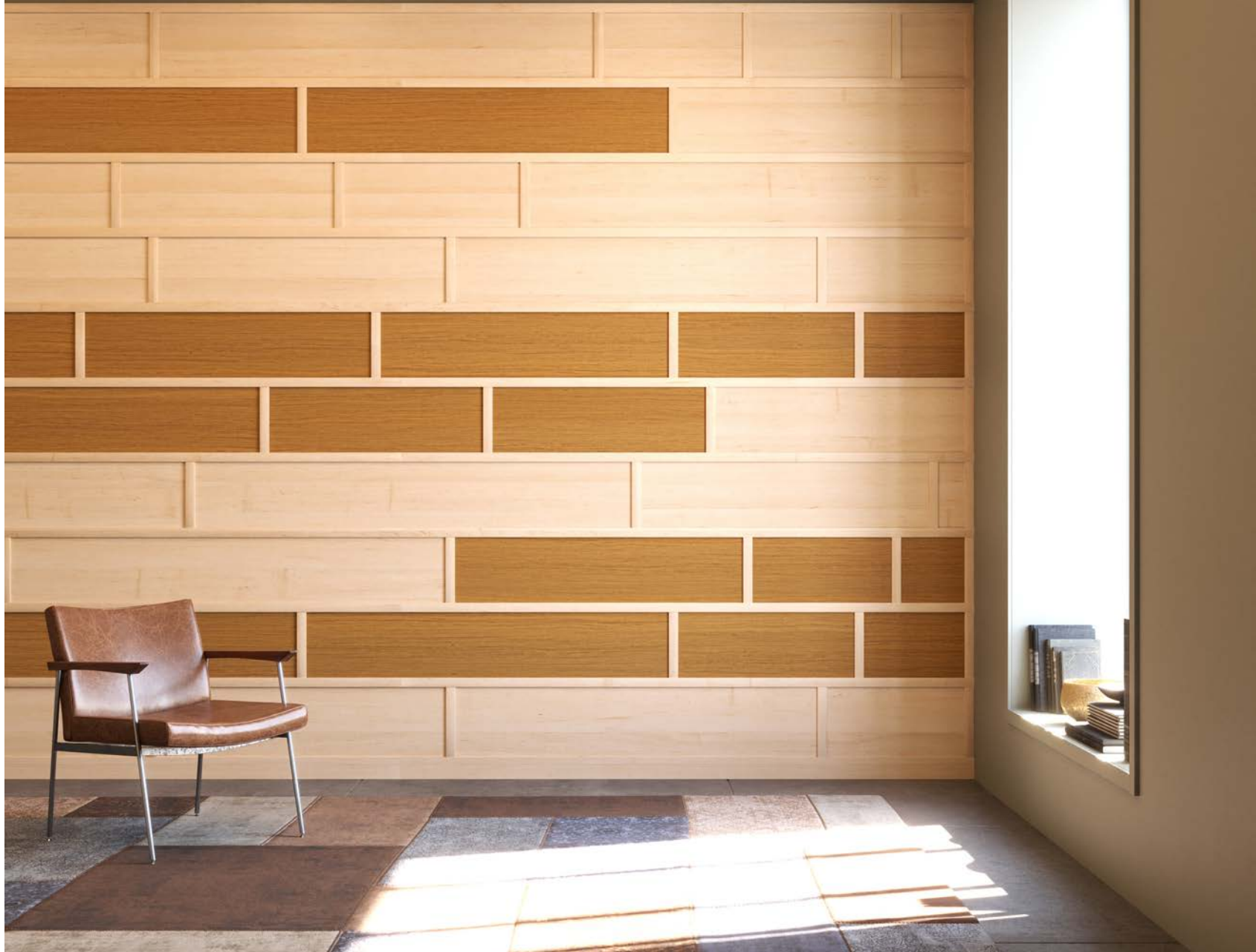

FREESTILE

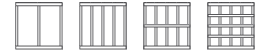

TIME SAVED

Compare the ease of installing Freestile to other common wall solutions.

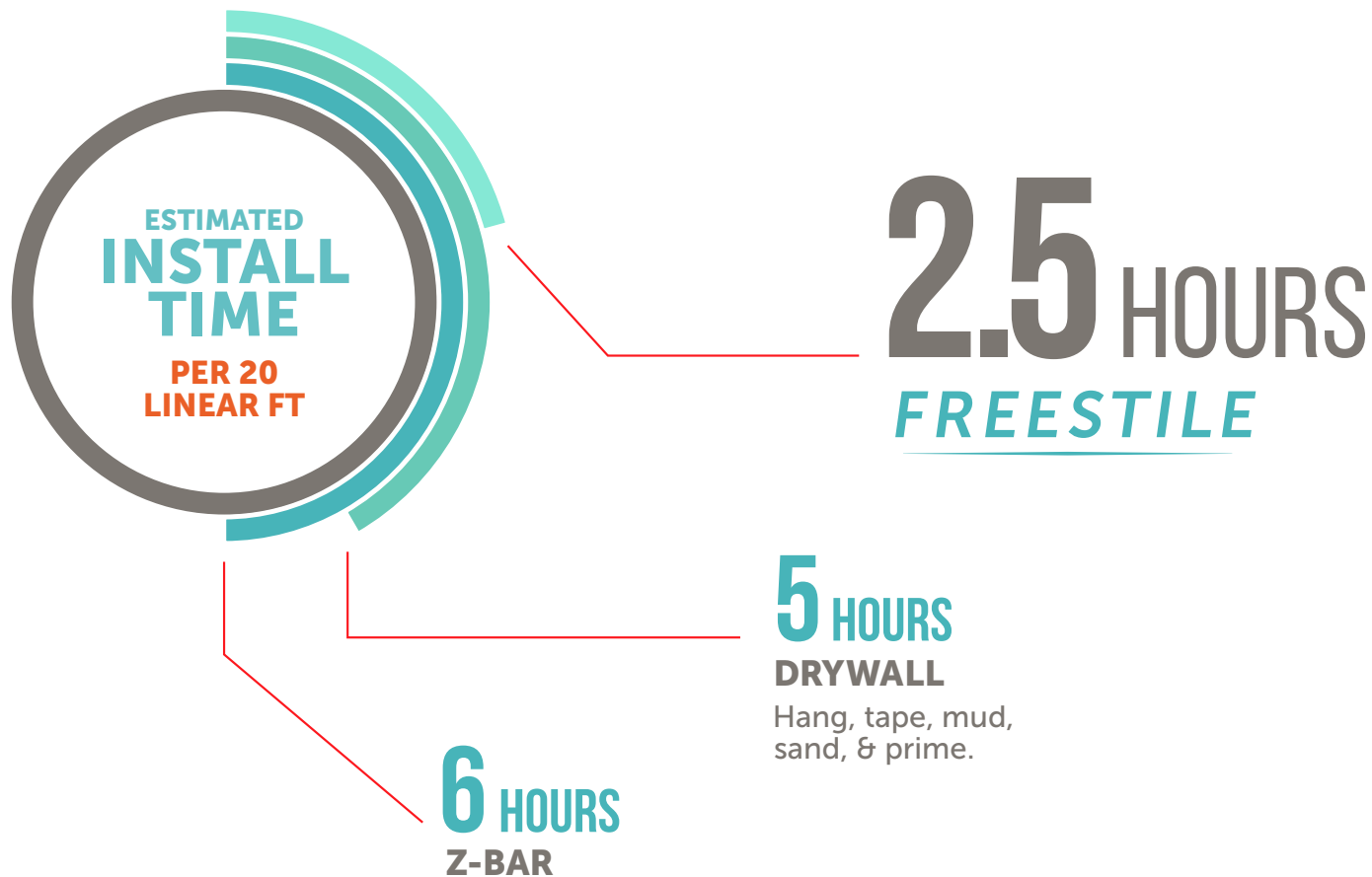

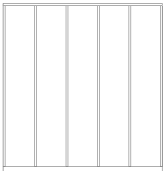

WALNUT



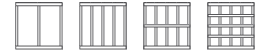

FINISH OPTIONS FROM LIGHT TO DARK

Offering a variety of natural wood species to provide you with a wide range of design possibilities.

MAPLE



ARCTIC OAK



WHITE OAK



HEMLOCK



TEAK



WALNUT



FUMED EUCALYPTUS

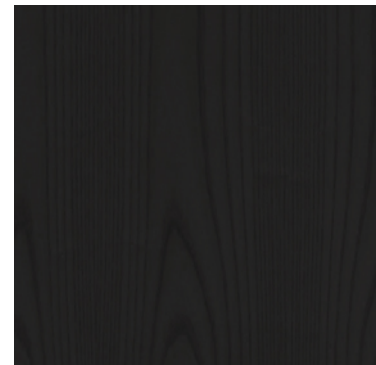

BLACKOUT ASH

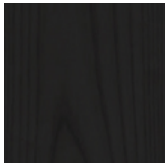
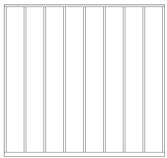

BLACKOUT ASH



FREESTILE



MATCHING TRIM

Standard trim with matching veneer that can be cut and installed in a variety of patterns.

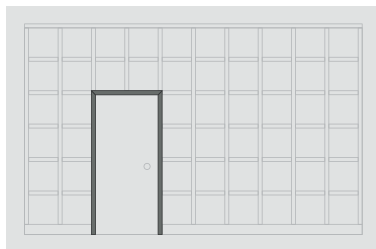

CASING:
2" X 1 1/2"

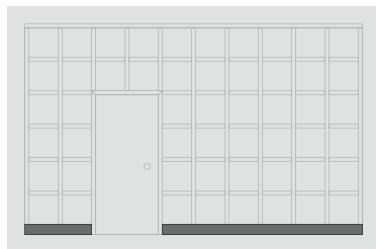

BASEBOARDS:
5" X 5/16"

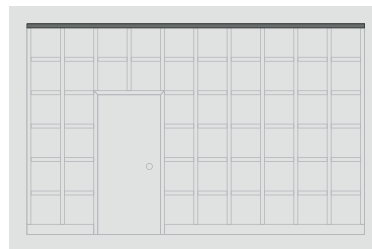

TOP RAILS:
1 1/2" X 5/16"

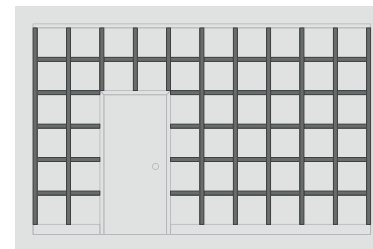

FIELD STILES & RAILS:
1 1/2" X 1/4"



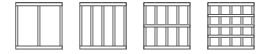

INNOVATIVE FASTENERS

Trim pieces are fastened with nearly invisible, headless pins, designed to fuse securely with SoundPly's engineered polymer core.

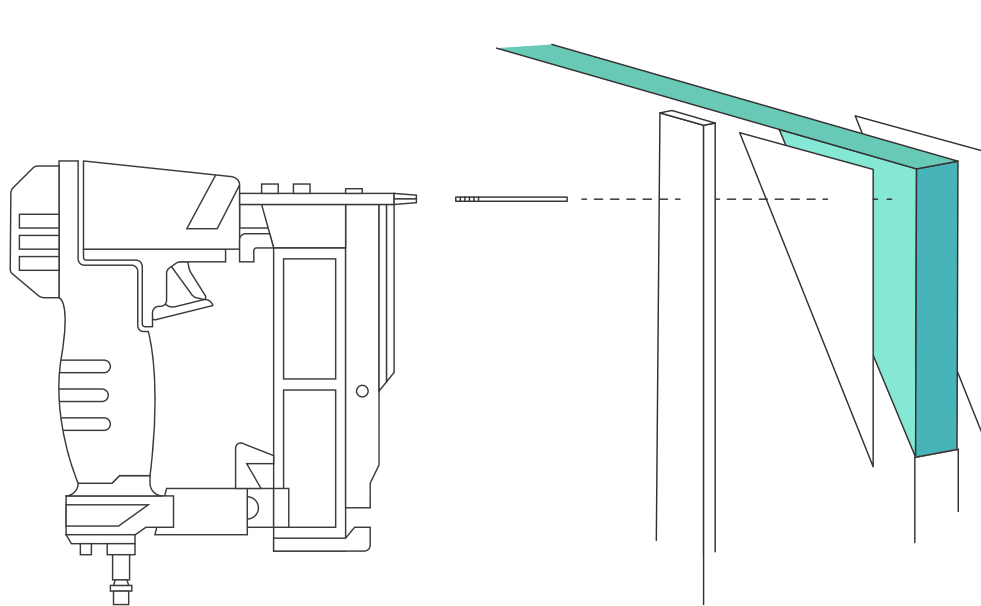

PINS (TOP & FIELD)
1 3/16" 23 X GAUGE

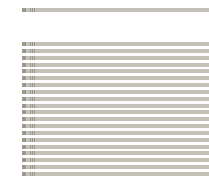

BRAD NAILS (CASING & BASE)
2 1/2" X 18 GAUGE



FEELING THE FREEDOM? LET'S TALK.

WE ARE HERE FOR YOU...

From specification to installation, working with Navy Island means having a single point of contact with you every step of the way, coordinating to ensure materials are on time, on grade, and as expected.

You have direct access to the manufacturer and therefore knowledge of the potential options and limits of any product. This lends to efficiency and the ability to customize and/or choose from ready options.

We also handle the details. From schedules and deliveries to fire code, sound ratings, and LEED credits, our expert staff simplify the process so you can focus on the results.

651.451.4454